

M32 Magnalock®

600 lbs holding force
direct mounted Magnalock

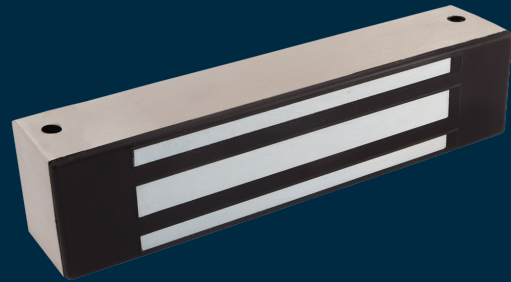

The ultimate in Magnalock reliability for indoor/outdoor traffic control.

The M32 electromagnetic lock is ideal for traffic control in high-use areas within secured or monitored perimeters. With unsurpassed durability, the M32 will last long after most buildings wear out. Applications include storage areas, rooms, and hallways where reliability, high durability and low-maintenance are required.

NOTE: M32-SS in cabinet lock section. See page #48.

Features

Standard Features

- Fire rated—3 hours
- PoE friendly
- Sustainability documentation
- Efficient, low power usage
- Automatic dual-voltage—no field adjustment required
- Fully sealed for weather resistant operations
- Size optimized for use with door closers
- Rust resistant—all ferrous metal surfaces plated for durability
- Instant release circuit—no residual magnetism
- Noise suppression with built-in MOV
- 10 ft [3.05m] of jacketed, stranded conductor cable
- Ultra-secure collapsing blind nuts mount to door frame for strength and reliability
- MagnaCare® lifetime replacement, no-fault, no questions asked warranty

Optional Features

- **F** Face drilled
- **B** Patented BondSTAT magnetic bond sensor
- **D** Integrated Door Position Switch (DPS)



Grade 3



MagnaCare
Warranty



Auto Sensing
Dual Voltage
12/24



PoE
Friendly



Fire Rated



Outdoor
Rated



Preload

Specifications

Certifications

- UL 10C Listed
- CAN4-S104, CAN/ULC-S533 Listed
- ANSI/UL 294 Listed
- CSA-C22.2 No.205 Listed
- ANSI/BHMA A156.23, Grade 3; E08501-500 Compliant
- CSFM—California State Fire Marshal Approved
- CE:EN 50081-1(92), EN 61000-6-2(99) Approved
- Environmental Product Declaration
- Health Product Declaration

Electrical

- 300 mA at 12 VDC
- 150 mA at 24 VDC

Holding Force

- 600 lbs [272kg]

Operating Temperature

- -40° to 140°F [-40° to 60°C]
- Indoor or Outdoor use

Shipping Weight

- 6 lbs [2.72kg]

Dimensions

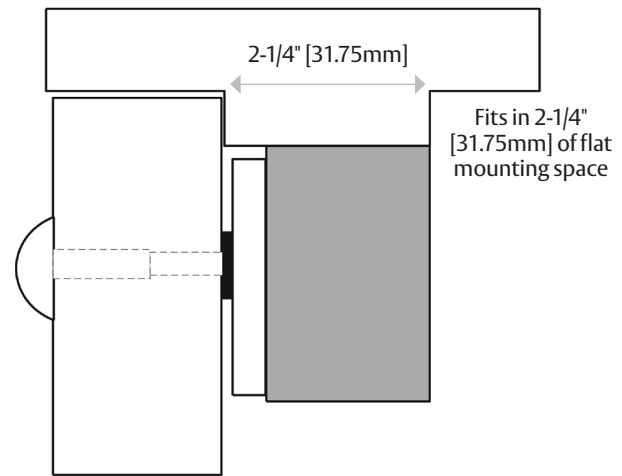
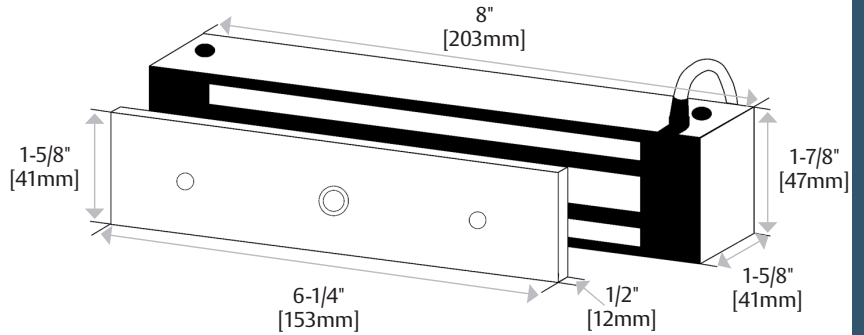

How to Order

MODEL SERIES	MOUNTING METHOD	MONITORING OPTIONS	STRIKE PLATE OPTIONS
M32	F	BD	- SS
M32 600 lbs	(blank) Direct Mount F Face Drilled	(blank) No Monitoring B BondSTAT Monitor D Door Position Switch BD BondSTAT and DPS	(blank) Standard Strike SS Split Strike* SASM Shock Absorbing Strike Mount

*D and BD monitoring, not available with (SS) Split Strike option.

M32, M62, M82 Magnalock® Accessories

ASB Aluminum Spacer Bracket

- Use when a blade stop requires the Magnalock to be lowered
- Comes pre-drilled for the mounting bolts and wire
- Provides a blind nut for surface installation of strike
- Available in clear aluminum or black anodized
- MagnaCare® lifetime replacement, no-fault, no questions asked warranty



PART NUMBER	DESCRIPTION	FINISH
ASB-32BK	Aluminum Frame Spacer Bracket – M32	Black Anodized
ASB-32CL	Aluminum Frame Spacer Bracket – M32	Clear Anodized
ASB-62BK	Aluminum Frame Spacer Bracket – M62	Black Anodized
ASB-62CL	Aluminum Frame Spacer Bracket – M62	Clear Anodized
ASB-82BK2	Aluminum Frame Spacer Bracket – M82	Black Anodized
ASB-82CL	Aluminum Frame Spacer Bracket – M82	Clear Anodized
ASCWB-DM62CL	Aluminum 1-1/2" [38.1mm] Spacer – Concrete/Wood Bracket, DM62	Clear

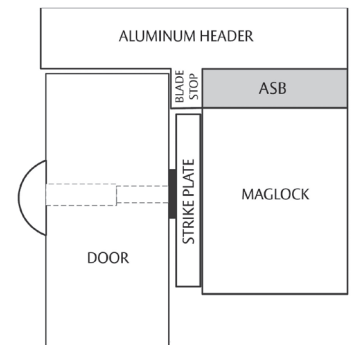

CWB Concrete Wood Bracket

- Used on wood or concrete filled metal frames
- Provides a concealed wire chamber
- Available in clear aluminum or black anodized
- MagnaCare® lifetime replacement, no-fault, no questions asked warranty



PART NUMBER	DESCRIPTION	FINISH
CWB-32BK	Concrete/Wood Bracket – M32	Black Anodized
CWB-32CL	Concrete/Wood Bracket – M32	Clear Anodized
CWB-62BK	Concrete/Wood Bracket – M62	Black Anodized
CWB-62CL	Concrete/Wood Bracket – M62	Clear Anodized
CWB-82BK	Concrete/Wood Bracket – M82	Black Anodized
CWB-82CL	Concrete/Wood Bracket – M82	Clear Anodized

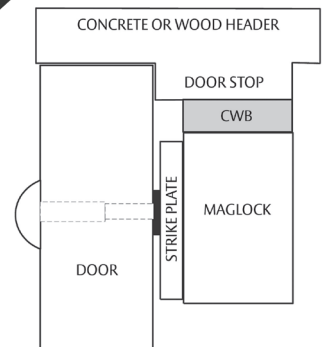

LIFE

MagnaCare
Warranty

SECURITRON
ASSA ABLOY

US securitron.com | 800 626 7590 | customerservice.securitron@assaabloy.com

Canada assaabloydss.ca | 800 461 3007 | sales.dss.ca@assaabloy.com

AOS Offset Strike Plate

- Alters the position of the mounting hole by 1/4" [6mm]. This is often required to clear the glass on aluminum frame store front doors.
- Includes Offset Strike Plate only.
- MagnaCare® lifetime replacement, no-fault, no questions asked warranty.

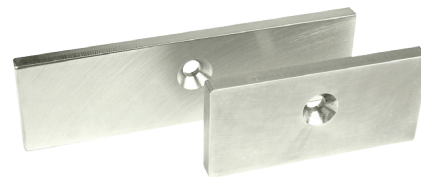

PART NUMBER	DESCRIPTION
AOS-62	Strike Plate – M62, Offset
AOS-62D	Strike Plate – M62D, Offset
AOS-82	Strike Plate – M82, Offset

ASS Split Strike/Replacement Strike Plate

- Allows a single M32, M62 or M82 Magnalock to secure a double door at traffic control holding force level.
- Includes Split Strike Plates only.
- MagnaCare® lifetime replacement, no-fault, no questions asked warranty.



PART NUMBER	DESCRIPTION
ASS-32	Strike Plate M32 – Split Set w/ Fasteners & Sex Bolt
ASS-62	Strike Plate M62 – Split Set w/ Fasteners & Sex Bolt
ASS-82	Strike Plate M82 – Split Set w/ Fasteners & Sex Bolt

ZA Z Bracket Kits – Adjustable

- Use on in-swing doors with Magnalock "F" options (8-1/2" [215.9mm] overall length).
- Provides 1-1/4" [31.75mm] of lateral movement to accommodate most openings and allows for precision adjustments (2-1/4" to 3-1/2" [57.15mm to 88.9mm] from door/header).
- Includes an oversized dress cover.
- MagnaCare® lifetime replacement, no-fault, no questions asked warranty.



PART NUMBER	DESCRIPTION	FINISH
ZA-32/62BK	Adjustable Z-Bracket – M32/62	Black Anodized
ZA-32/62CL	Adjustable Z-Bracket – M32/62	Clear Anodized
ZA-32/62SS	Adjustable Z-Bracket – M32/62	Satin Stainless
ZA-82BK	Adjustable Z-Bracket – M82	Black Anodized
ZA-82CL	Adjustable Z-Bracket – M82	Clear Anodized
ZA-82SS	Adjustable Z-Bracket – M82	Satin Stainless

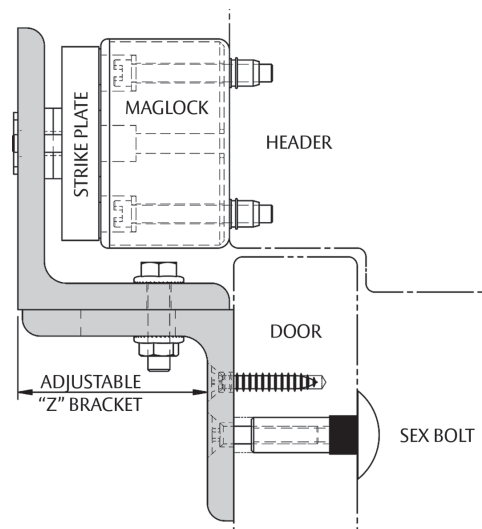

EASB Energy Absorbing Sex Bolt

The Energy Absorbing Sex Bolt provides additional protection and shock absorption to augment holding force when a door experiences dynamic forces such as kicks or repeated blows. Used in mental health care and detention ancillary or administrative doors, and perimeter doors.

- For high-security applications on inflexible doors.
- Replaces the standard Sex Bolt.
- Contains a powerful internal spring that absorbs and dissipates the force of a blow.
- MagnaCare® lifetime replacement, no-fault, no questions asked warranty.

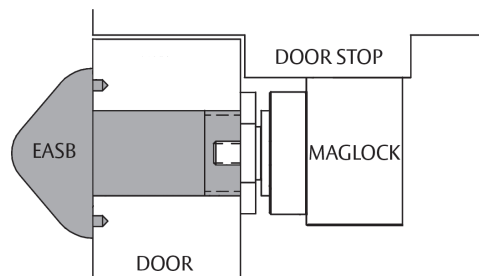

PART NUMBER	DESCRIPTION
EASB-250	Energy Absorbing Bolt – 1/4" [6.35mm] Spacer Kit
EASB-32	Energy Absorbing Sex Bolt – Model 32
EASB-62	Energy Absorbing Sex Bolt – Model 62
EASB-82	Energy Absorbing Sex Bolt – Model 82

TDK-1 Accessory for Thick Doors

- Provides replacement screws so armature plates for the M32, M62, M82, M38 and M68 can be used on doors thicker than 1-3/4" [44.45mm], and up to 3" [76.2mm].
- MagnaCare® lifetime replacement, no-fault, no questions asked warranty.



PART NUMBER	DESCRIPTION
TDK-1	Thick Door Kit

SB-1 Sex Bolt Replacement

- Replaces armature plate sex bolt for M32, M38, M62, M68 and M82B Magnalocks.
- Available in clear, polished brass or oil rubbed bronze finish.
- MagnaCare® lifetime replacement, no-fault, no questions asked warranty.



PART NUMBER	DESCRIPTION	FINISH
SB-1	Sex Bolt – Replacement	Clear
SB-1-03	Sex Bolt – Replacement	Polished Brass
SB-1-10B	Sex Bolt – Replacement	Oil-Rubbed Bronze



M32/62/82 Magnalock Accessories

DC Dress Covers

- Use with M32, M62, and M82.
- Install using foam adhesive tape.
- Available in clear, black, polished stainless and polished brass finish.
- MagnaCare® lifetime replacement, no-fault, no questions asked warranty.

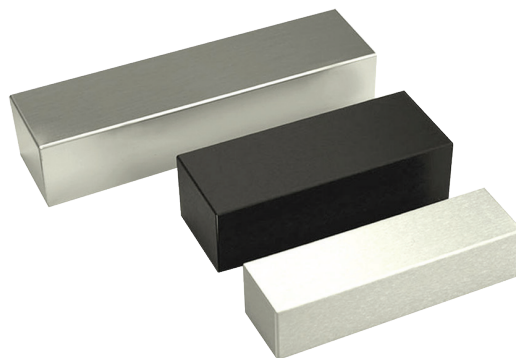

PART NUMBER	DESCRIPTION	COLOR
DC-32BK	DC – M32	Black Anodized
DC-32BP	DC – M32	Brass Polished
DC-32CL	DC – M32	Clear Anodized
DC-32SP	DC – M32	Stainless Polished
DC-62BK	DC – M62	Black Anodized
DC-62BP	DC – M62	Brass Polished
DC-62CL	DC – M62	Clear Anodized
DC-62SP	DC – M62	Stainless Polished
DC-82BK	DC – M82	Black Anodized
DC-82BP	DC – M82	Brass Polished
DC-82CL	DC – M82	Clear Anodized
DC-82SP	DC – M82	Stainless Polished

DDC Double Dress Covers

- Use with M32/M62.
- Available in clear anodized and black finish.
- Will cover a pair of Magnalocks on a double door (if they are separated by no more than 2").
- Not for use with the DM62 Magnalock.
- MagnaCare® lifetime replacement, no-fault, no questions asked warranty.

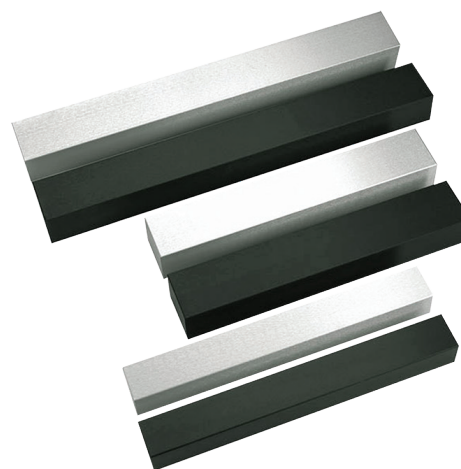

PART NUMBER	DESCRIPTION	COLOR
DDC-32CL	DDC – M32	Clear Anodized
DDC-32BK	DDC – M32	Black Anodized
DDC-62CL	DDC – M62	Clear Anodized
DDC-62BK	DDC – M62	Black Anodized

MTK Metal Marking Template

- Magnetic template streamlines installation for the M32 and M62 Magnalocks.
- Includes basic instructions and hole placements.

PART NUMBER	DESCRIPTION
MTK-32/62	Metal Marking Template



HHD / HHSL / HHSR / HVD Full Length Housings

- Vertical or horizontal configurations
- Fit one or two locks (not included)
- (SLR) Single Left Hand Reverse
- (SRR) Single Right Hand Reverse
- MagnaCare® lifetime replacement, no-fault, no questions asked warranty

HHD Horizontal Housing Dimensions

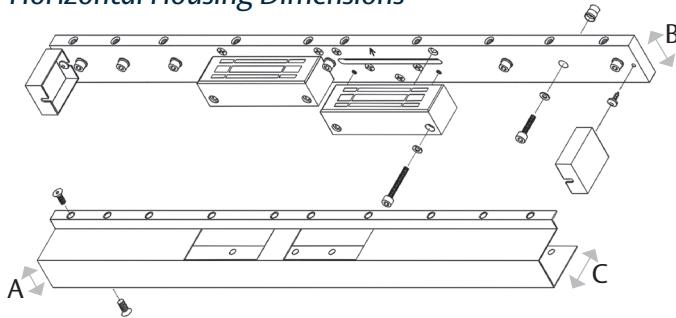

Model	A	B	C	Max Length*
HHD-32	1-3/4" [44.45mm]	2-3/32" [53.34mm]	2-11/32" [59.9mm]	96" [2438.4mm]
HHD-62	2-3/32" [53.34mm]	2-39/64" [66mm]	3-1/2" [88.9mm]	96" [2438.4mm]
HHD-82	2-3/32" [53.34mm]	2-39/64" [66mm]	3-1/2" [88.9mm]	96" [2438.4mm]
HHSL-32	1-3/4" [44.45mm]	2-3/32" [53.34mm]	2-23/64" [59.7mm]	48" [1219.2mm]
HHSL-62	2-3/32" [53.34mm]	2-39/64" [66mm]	3-1/2" [88.9mm]	48" [1219.2mm]
HHSR-32	1-3/4" [44.45mm]	2-3/32" [53.34mm]	2-23/64" [59.7mm]	48" [1219.2mm]
HHSR-62	2-3/32" [53.34mm]	2-39/64" [66mm]	3-1/2" [88.9mm]	48" [1219.2mm]
HVD-32	1-3/4" [44.45mm]	2-3/32" [53.34mm]	2-23/64" [59.7mm]	96" [2438.4mm]
HVD-62	2-3/32" [53.34mm]	2-39/64" [66mm]	3-1/2" [88.9mm]	96" [2438.4mm]
HVD-82	2-3/32" [53.34mm]	2-39/64" [66mm]	3-1/2" [88.9mm]	96" [2438.4mm]

*Full length housings are individually manufactured to custom specifications up to the maximum length shown.



PART NUMBER DESCRIPTION

HHD-32	Lock Housing for M32 – Dbl. Horizontal
HHD-62	Lock Housing for M62 – Dbl. Horizontal
HHD-82	Lock Housing for M82 – Dbl. Horizontal
HHSL-32	Lock Housing for M32 – SLR Horizontal
HHSL-62	Lock Housing for M62 – SLR Horizontal
HHSR-32	Lock Housing for M32 – SRR Horizontal
HHSR-62	Lock Housing for M62 – SRR Horizontal
HVD-32	Lock Housing for M32 – Dbl. Vertical
HVD-62	Lock Housing for M62 – Dbl. Vertical
HVD-82	Lock Housing for M82 – Dbl. Vertical

How to Order

Specify quantity and the following information. Order related products separately.

MODEL SERIES	MOUNTING METHOD	SPECIFY LENGTH
HHD	-32	(83")
HHD	32	HHD Max Length 96"
HHSL	62	HHD Max Length 96"
HHSR	82	HHSR Max Length 48"
HVD		HVD Max Length 96"

NOTE: Configurable parts HHSL-82 and HHSR-82 have been discontinued. Not every combination is possible. Please contact the factory if you need a combination of features not listed above.



MagnaCare
Warranty